

K I N G



DT2018567-V12

kingliving.com

Jasper

# Jasper Components

## Platforms

D1040 (41") H240 (9.5")

### P78



780 (30.75")

### P104



1040 (41")

### P130



1300 (51.25")

### P156



1560 (61.25")

### P182



1820 (71.75")

### P208



2080 (82")

### P234



2340 (92.25")

### P260



2600 (102.25")

## Seat Cushions

D780 (30.75") H200 (7.75")

### C78



780 (30.75")

### C91



910 (35.75")

### C104



1040 (41")

### C156

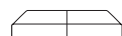

1560 (61.5")

### C182

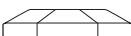

1820 (71.75")

### C208

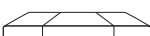

2080 (82")

## Platforms (Deep)

D1300 (51.25") H240 (9.5")

### P104D



1040 (41")

### P130D



1300 (51.25")

### P182D

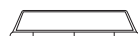

1820 (71.75")

### P208D

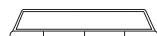

2080 (82")

### P234D



2340 (92.25")

## Seat Cushions (Deep)

D1040 (41") H200 (7.75")

### C104D



1040 (41")

### C156D

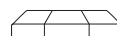

1560 (61.5")

### C182D

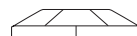

1820 (71.75")

### C208D

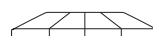

2080 (82")

## Storage Bases

D1040 (41") H240 (9.5")

### S Base 182 S156 RH

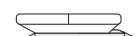

1820 (71.75")

### S Base 182 S156 LH

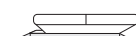

1820 (71.75")

### S Base 234 S208 RH

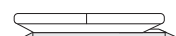

2340 (92.25")

### S Base 234 S208 LH

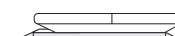

2340 (92.25")

### S Base 182 S78 RH



1820 (71.75")

### S Base 182 S78 LH



1820 (71.75")

## Storage Bases (Deep)

D1300 (51.25") H240 (9.5")

### S Base 208D S104 RH



2080 (82")

### S Base 208D S104 LH



2080 (82")

## Corner

P130 Corner

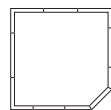

1300 (51.25")

## Seat Cushion

C104 78 CORNER

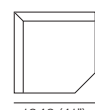

1040 (41")

## Curved Corner

Seat Cushion:

C-CNR R104

## Platform:

P-CNR R130  
use with CNR R130 or  
T-CNR-R130

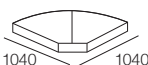

1040 (41") 1040 (41")

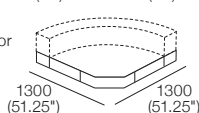

1300 (51.25") 1300 (51.25")

Curve Cnr Top View  
with **CNR R130**  
(Upholstered)



1300 (51.25")

Curve Cnr Top View  
with **T-CNR-R130**  
(Timber Veneer Shelf)



1300 (51.25")

## Storage Base: S Ottoman 104-D78

D780 (30.75") H240 (9.5")



1040 (41")

# Jasper

## Components | Accessories

### Arms / Backs

W260 (10.25") H310 (12.25")

#### A78



780 (30.75")

#### A78 SMART



780 (30.75")

#### A104



1040 (41")

#### A104 SMART



1040 (41")

#### A130



1300 (51.25")

#### A130 SMART



1300 (51.25")

#### A156



1560 (61.5")

#### A156 SMART



1560 (61.5")

#### A182

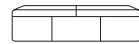

1820 (71.75")

#### A182 SMART

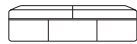

1820 (71.75")

#### A208



2080 (82")

#### A208 SMART



2080 (82")

### Timber Veneer Shelves

W260 (10.25") H310 (12.25")

#### Shelf T78 or T78 Light-Charge



780 (30.75")

#### Shelf T104 or T104 Light-Charge



1040 (41")

#### Arm/Back CNR R130 or CNR R130 SMART Upholstered



1300 (51.25")

#### Shelf T-CNR-R130



1300 (51.25")

### Back Cushions

Front View  
H500 (19.75")

#### B78



780 (30.75")

#### B91



910 (36")

#### B104



1040 (41")

### Back Cushions: Leather

Rear Detail: Bolster, Stitching, Tricot, Perforation

#### B78



#### B91



#### B104

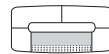

### Media Console

MC52  
D1040 (41")

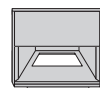

520 (20.5")

#### MC38

D1040 (41")



380 (15")

### Jasper Speaker Bracket SO

Compatible with: Sonos Play 1; Sonos One; Sonos One SL

120 (4.75")

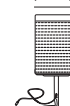

160 (6.25")



120 (4.75")

### Jasper Speaker Bracket SE

Compatible with: Sonos Era 100

120 (4.75")

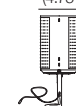

184 (7.25")



130 (5")

#### RND CHARGE TrayTable Carrara Marble



350 (13.75")

#### RND TrayTable CARRARA Carrara Marble



350 (13.75")

#### Sofa Light 1214 Timber Veneer

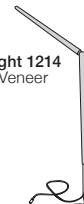

#### Tray CARRARA 350 Carrara Marble



350 (13.75")

#### Tray Timber 350 Timber Veneer



350 (13.75")

#### RND TrayTable Timber Veneer



350 (13.75")

#### REC Table 104 Timber Veneer W260 (10.25")



1040 (41")

#### REC Table 78 Timber Veneer W260 (10.25")



780 (30.75")

### Bed Brackets





# K I N G



DT2018658-V4

[kingliving.com](http://kingliving.com)

Jasper  
Packages

# Jasper Packages

**Package: 13 (STD or SMART\*)**

Components: 2x P182, 2x C156, 1x A104 SMART, 1x A156, 1x A78, 3x B78. Shelves: STD included: 1x T104, 1x T78.

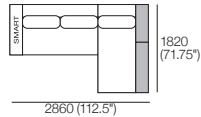

**Package: 13 SLH (STD or SMART\*)**

Components: 1x SBase 182 S156 RH, 1x SBase 182 S78 LH, 1x A104 SMART, 1x A156, 1x A78, 3x B78. Shelves: STD included: 1x T104, 1x T78.

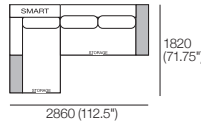

**Package: 13 SRH (STD or SMART\*)**

Components: 1x SBase 182 S156 LH, 1x SBase 182 S78 RH, 1x A104 SMART, 1x A156, 1x A78, 3x B78. Shelves: STD included: 1x T104, 1x T78.

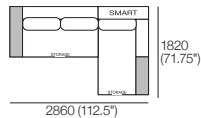

**Package: 13U (STD or SMART\*)**

Components: 2x P182, 2x C156, 2x A104 SMART, 1x A156, 2x A78, 3x B78.

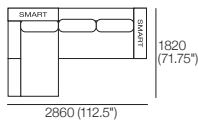

**Package: 1A (STD or SMART\*)**

Components: 1x P234, 1x P208D, 2x C104, 1x C182D, 1x A208, 1x A104, 1x A104 SMART, 3x B104. Shelves: STD included: 2x T104.

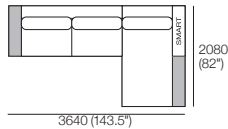

**Package: 1A SLH (STD or SMART\*)**

Components: 1x SBase 208D S104 LH, 1x SBase 234 S208 RH, 1x A208, 1x A104, 1x A104 SMART, 3x B104. Shelves: STD included: 2x T104.

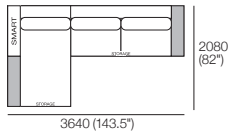

**Package: 1A SRH (STD or SMART\*)**

Components: 1x SBase 208D S104 RH, 1x SBase 234 S208 LH, 1x A208, 1x A104, 1x A104 SMART, 3x B104. Shelves: STD included: 2x T104.

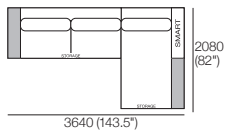

**Package: 13U SLH (STD or SMART\*)**

Components: 1x SBase 182 S156 RH, 1x SBase 182 S78 LH, 1x A156, 2x A104 SMART, 2x A78, 3x B78.

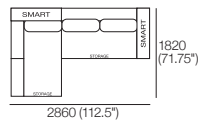

**Package: 9 (STD or SMART\*)**

Components: 1x P234, 1x P208, 2x C104, 1x C182, 1x A208, 1x A104, 1x A104 SMART, 2x B104, 1x B78. Shelves: STD included: 1x T104, 1x T78.

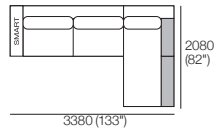

**Package: 9 SLH S234 (STD or SMART\*)**

Components: 1x SBase 234 S208 RH, 1x P208, 1x C182, 1x A208, 1x A104, 1x A104 SMART, 2x B104, 1x B78. Shelves: STD included: 1x T104, 1x T78.

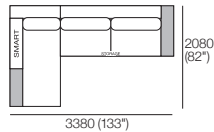

**Package: 9 SRH S234 (STD or SMART\*)**

Components: 1x SBase 234 C208 LH, 1x P208, 1x C182, 1x A208, 1x A104, 1x A104 SMART, 2x B104, 1x B78. Shelves: STD included: 1x T104, 1x T78.

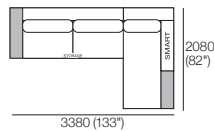

**Package: 7 (STD or SMART\*)**

Components: 1x P208, 1x P182, 1x P234, 1x C182, 1x C156, 2x C104, 1x A104, 2x A104 SMART, 1x A78, 1x A208, 2x B104, 2x B78. Shelves: STD included: 1x T104, 2x T78.

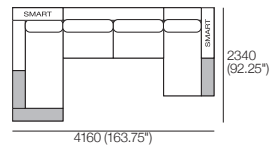

**Package: 7 SLH 182 (STD or SMART\*)**

Components: 1x SBase 182 S78 LH, 1x P234, 1x P208, 1x C182, 2x C104, 1x A208, 1x A104, 2x A104 SMART, 1x A78, 2x B104, 2x B78. Shelves: STD included: 1x T104, 2x T78.

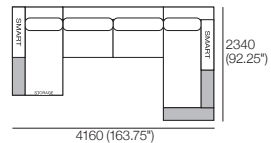

**Package: 7 SRH 182 (STD or SMART\*)**

Components: 1x SBase 182 S78 RH, 1x P234, 1x P208, 1x C182, 2x C104, 1x A208, 1x A104, 2x A104 SMART, 1x A78, 2x B104, 2x B78. Shelves: STD included: 1x T104, 2x T78.

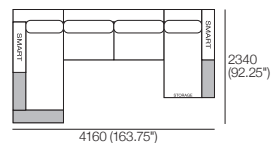

**Package: 13U SRH (STD or SMART\*)**

Components: 1x SBase 182 S156 LH, 1x SBase 182 S78 RH, 1x A156, 2x A104 SMART, 2x A78, 3x B78.

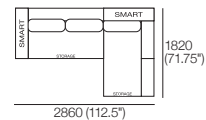

**Package: 7W (STD or SMART\*)**

Components: 1x P208, 1x P208D, 1x P234, 1x C182D, 1x C182, 2x C104, 2x A104, 2x A104 SMART, 1x A208, 3x B104, 1x B78. Shelves: STD included: 2x T104, 1x T78.

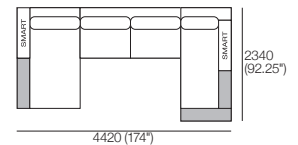

**Package: 7W SLH 208D (STD or SMART\*)**

Components: 1x SBase 208D S104 LH, 1x P208, 1x P234, 1x C182, 2x C104, 2x A104, 2x A104 SMART, 1x A208, 3x B104, 1x B78. Shelves: STD included: 2x T104, 1x T78.

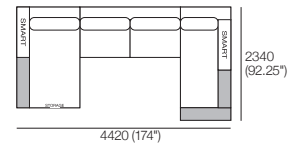

**Package: 7W SRH 208D (STD or SMART\*)**

Components: 1x SBase 208D S104 RH, 1x P208, 1x P234, 1x C182, 2x C104, 2x A104, 2x A104 SMART, 1x A208, 3x B104, 1x B78. Shelves: STD included: 2x T104, 1x T78.

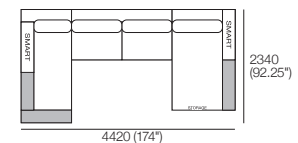

Effective March 2024. Use Magic Joiner M115. Shelves (Timber Veneer): STD (included); or Light-Charge (sold separately) available in selected King Living timber finishes. Bed Brackets sold separately. \*SMART Packages shown. STD Packages: A104 SMART Arm/Arms replaced by A104 STD Arm/Arms. King Living has a policy of continuous improvement, changes to products and specifications may be made without prior notice. Images and drawings are representative of design only. Accessories not included.

**K I N G**



DT2018645-V4

kingliving.com

Jasper 1A

# Jasper 1A

Jasper can easily be reconfigured to suit your lifestyle and space.

## Jasper 1A (STD Arms)

Components: 1x P234, 1x P208D, 2x C104, 1x C182D, 1x A208, 2x A104, 3x B104.

\*Shelves: STD (included); or Light-Charge (sold separately): 2x T104.

Configurations:

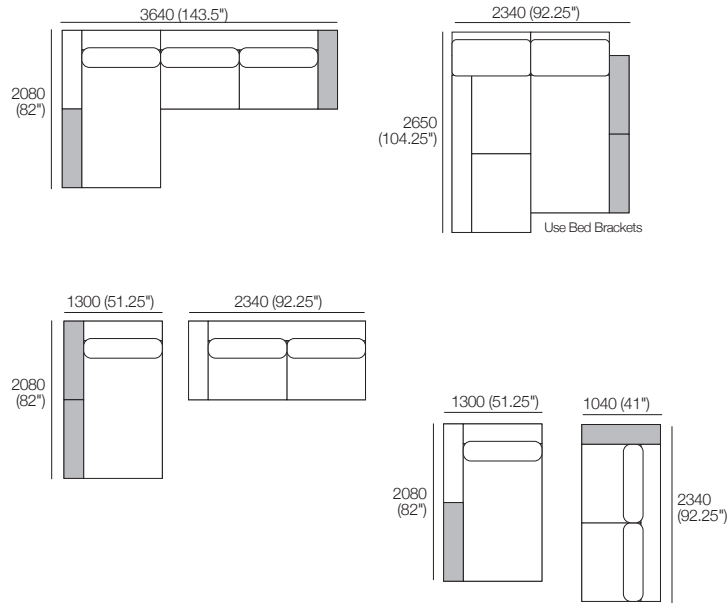

## Jasper 1A SMART\* (1x A104 SMART Arm replaces 1x A104 STD Arm)

\*SMART Arms compatible with SMART Accessories: Brackets | Lights | Tables | Wireless Device Charging.

Components: 1x P234, 1x P208D, 2x C104, 1x C182D, 1x A208, 1x A104, 1x A104 SMART, 3x B104.

\*Shelves: STD (included); or Light-Charge (sold separately): 2x T104.

Configurations:

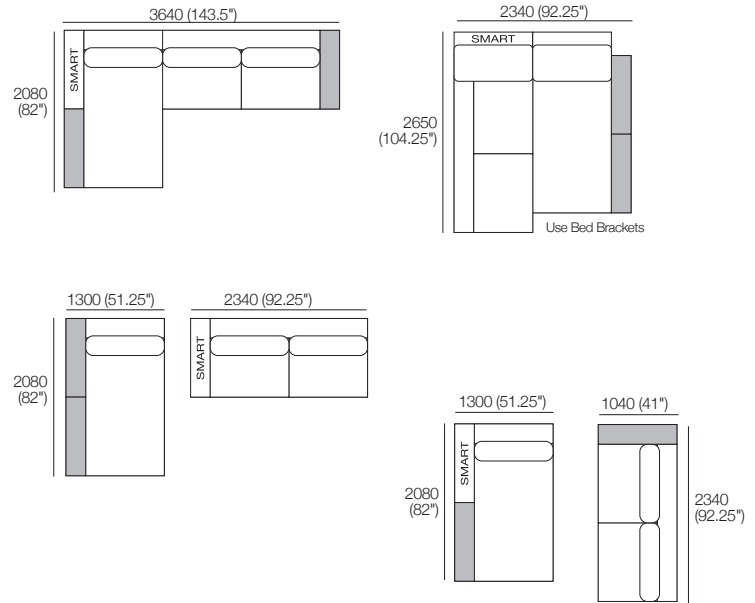



# Jasper 1A SLH (S: storage | LH: left-hand chaise)

Jasper can easily be reconfigured to suit your lifestyle and space.

## Jasper 1A SLH (STD Arms)

Components: 1x SBase 208D S104 LH, 1x SBase 234 S208 RH, 1x A208, 2x A104, 3x B104.

\*Shelves: STD (included); or Light-Charge (sold separately): 2x T104.

Configurations:

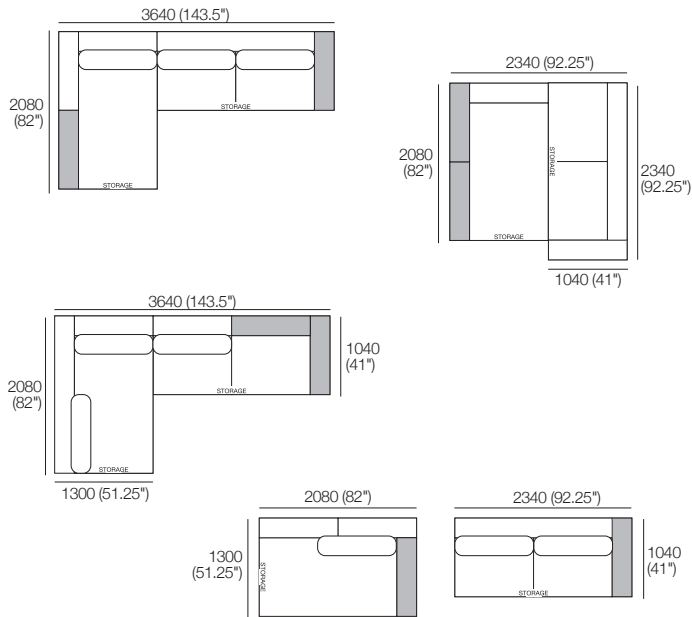

## Jasper 1A SLH SMART\* (1x A104 SMART Arm replaces 1x A104 STD Arm)

\*SMART Arms compatible with SMART Accessories: Brackets | Lights | Tables | Wireless Device Charging.

Components: 1x SBase 208D S104 LH, 1x SBase 234 S208 RH, 1x A208, 1x A104, 1x A104 SMART, 3x B104.

\*Shelves: STD (included); or Light-Charge (sold separately): 2x T104.

Configurations:

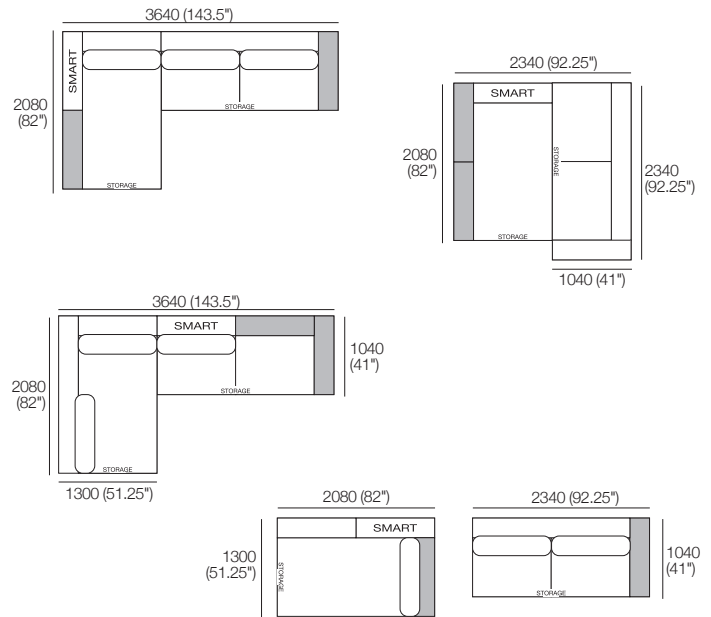

# Jasper 1A SRH (S: storage | RH: right-hand chaise)

Jasper can easily be reconfigured to suit your lifestyle and space.

## Jasper 1A SRH (STD Arms)

Components: 1x SBASE 208D S104 RH, 1x SBASE 234 S208 LH, 1x A208, 2x A104, 3x B104.

\*Shelves: STD (included); or Light-Charge (sold separately): 2x T104.

Configurations:

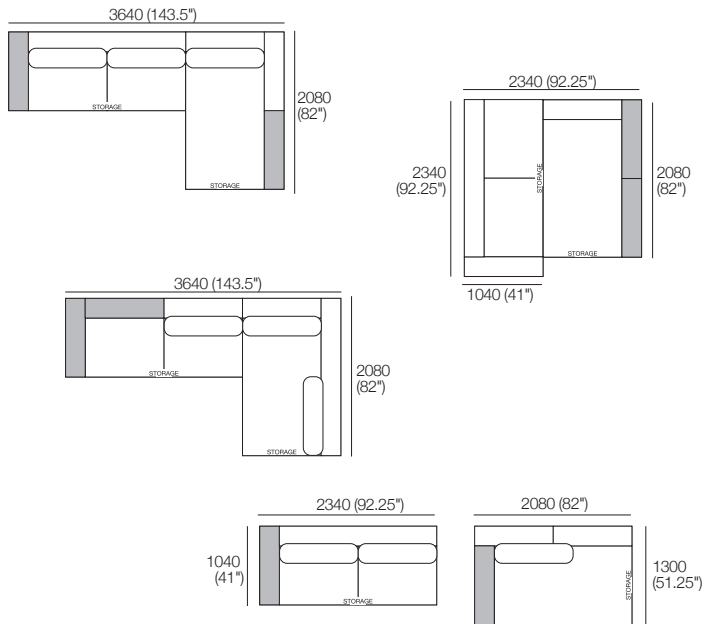

## Jasper 1A SRH SMART\* (1x A104 SMART Arm replaces 1x A104 STD)

\*SMART Arms compatible with SMART Accessories: Brackets | Lights | Tables | Wireless Device Charging.

Components: 1x SBASE 208D S104 RH, 1x SBASE 234 S208 LH, 1x A208, 1x A104, 1x A104 SMART, 3x B104.

\*Shelves: STD (included); or Light-Charge (sold separately): 2x T104.

Configurations:

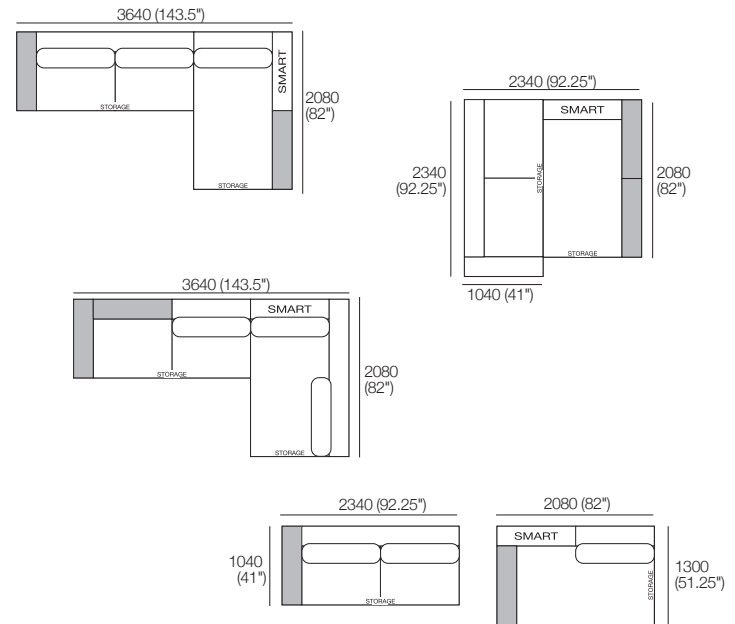

# K I N G



DT2018647-V6

[kingliving.com](http://kingliving.com)

Jasper 7

# Jasper 7

Jasper can easily be reconfigured to suit your lifestyle and space.

**Jasper 7** (STD Arms) / or **Jasper 7 SMART\*** (2x A104 SMART Arms replace 2x A104 STD Arms)

\*SMART Arms compatible with SMART Accessories: Brackets | Lights | Tables | Wireless Device Charging.

Components: 1x P208, 1x P182, 1x P234, 1x C182, 1x C156, 2x C104, 3x A104, 1x A78, 1x A208, 2x B104, 2x B78.

\*Shelves: STD (included); or Light-Charge (sold separately): 1x T104, 2x T78.

Configurations (SMART Arms shown):

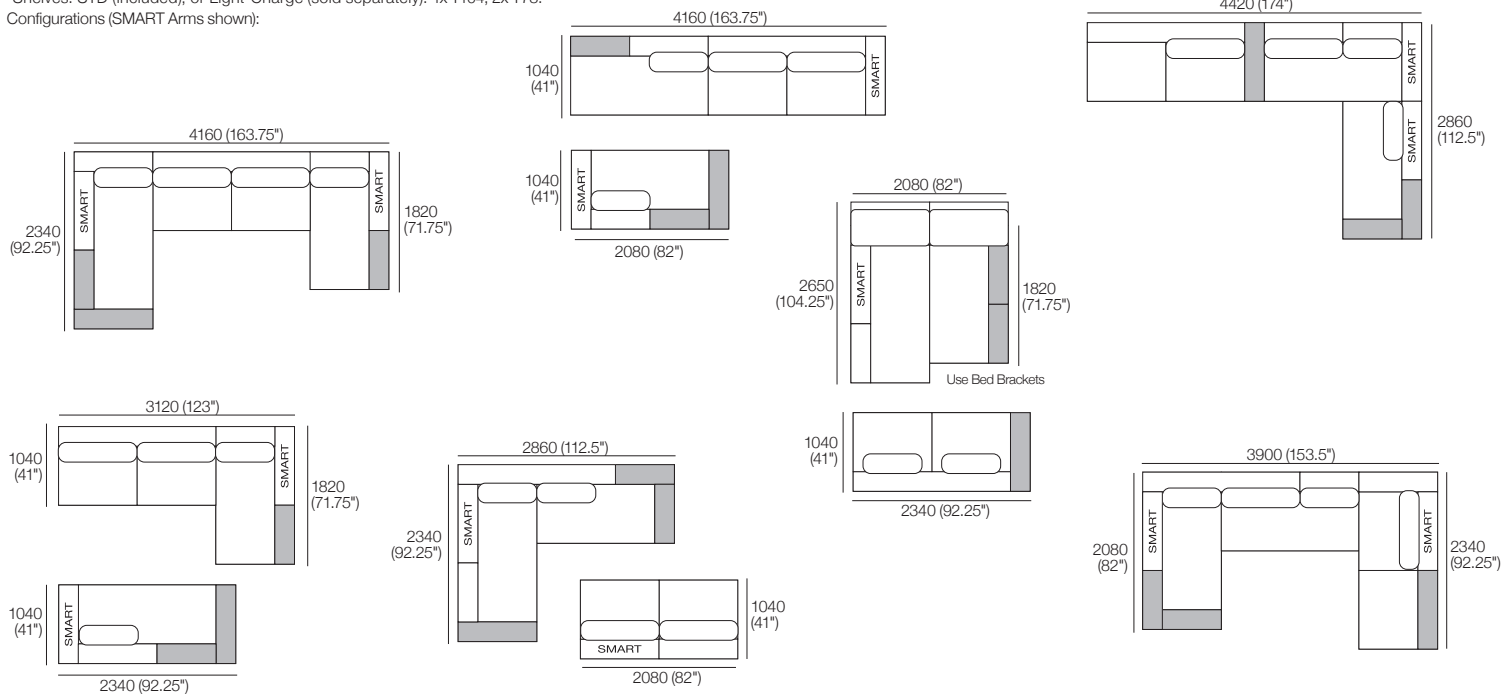

# Jasper 7 SLH 182 (S: storage | LH: left-hand chaise)

Jasper can easily be reconfigured to suit your lifestyle and space.

**Jasper 7 SLH 182** (STD Arms) / or **Jasper 7 SLH 182 SMART\*** (2x A104 SMART Arms replace 2x A104 STD Arms)

\*SMART Arms compatible with SMART Accessories: Brackets | Lights | Tables | Wireless Device Charging.

Components: 1x SBase 182 S78 LH, 1x P234, 1x P208, 1x C182, 2x C104,

1x A208, 3x A104, 1x A78, 2x B104, 2x B78.

\*Shelves: STD (included); or Light-Charge (sold separately): 1x T104, 2x T78.

Configurations (SMART Arms shown):

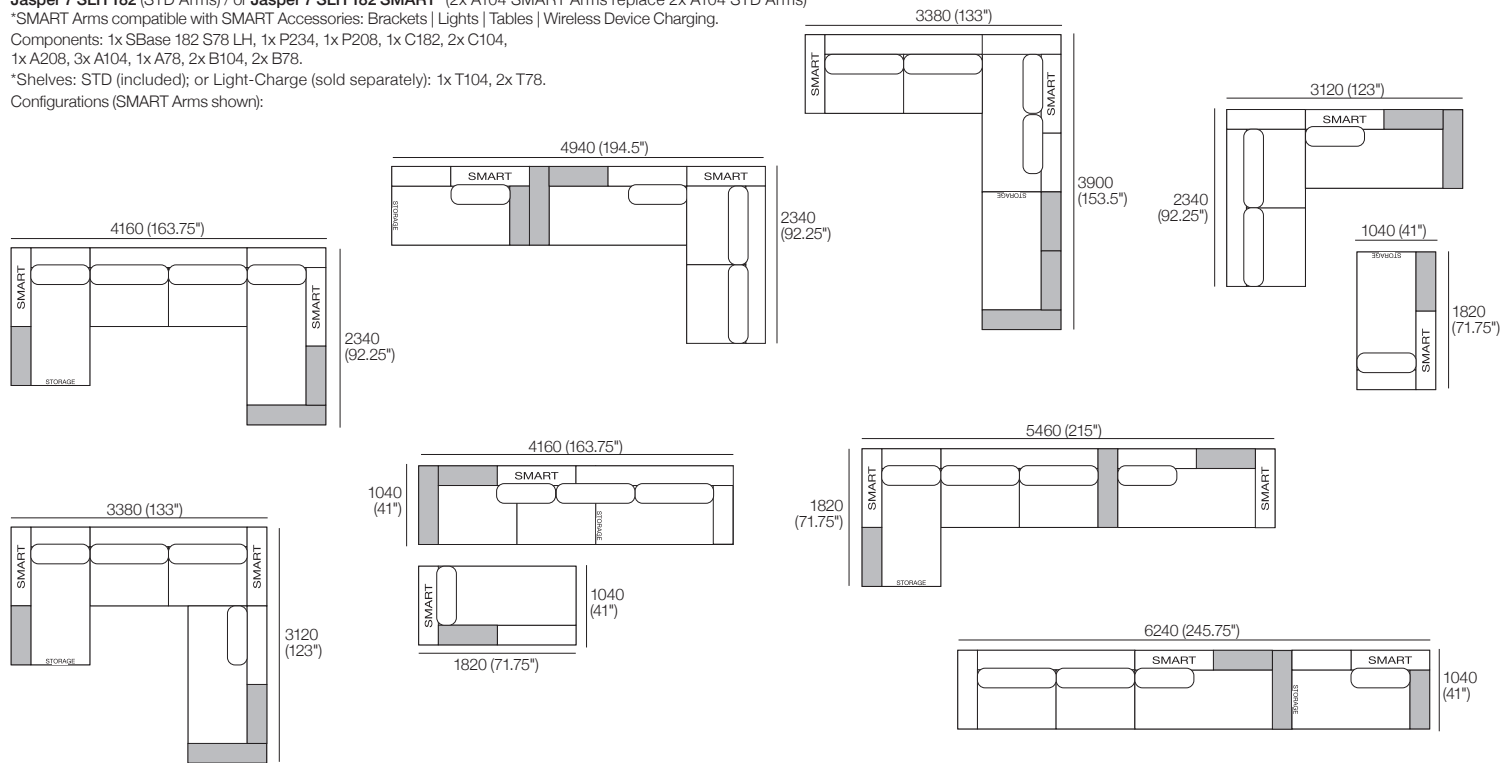

# Jasper 7 SRH 182 (S: storage | RH: right-hand chaise)

Jasper can easily be reconfigured to suit your lifestyle and space.

**Jasper 7 SRH 182 (STD Arms)** / or **Jasper 7 SRH 182 SMART\*** (2x A104 SMART Arms replace 2x A104 STD Arms)

\*SMART Arms compatible with SMART Accessories: Brackets | Lights | Tables | Wireless Device Charging.

Components: 1x SBase 182 S78 RH, 1x P234, 1x P208, 1x C182, 2x C104,

1x A208, 3x A104, 1x A78, 2x B104, 2x B78.

\*Shelves: STD (included); or Light-Charge (sold separately): 1x T104, 2x T78.

Configurations (SMART Arms shown):

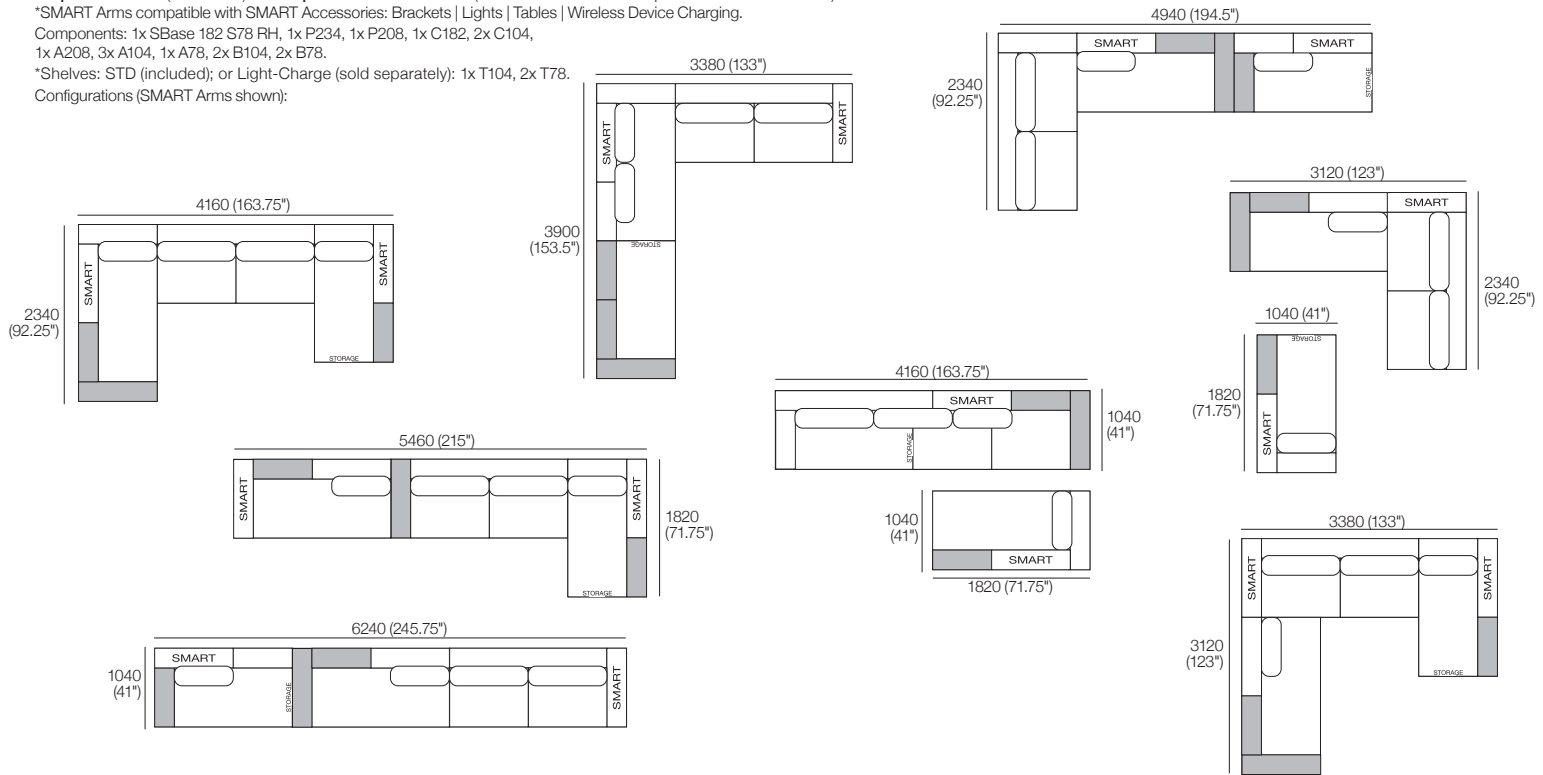

Effective February 2024. Use Magic Joiner M115. Bed Brackets sold separately. \*Shelves (Timber Veneer): STD (included); or Light-Charge (sold separately) available in selected King Living timber finishes. King Living has a policy of continuous improvement, changes to products and specifications may be made without prior notice. Images and drawings are representative of design only. Accessories not included.

**K I N G**



DT2020006-V7

kingliving.com

Jasper 7W

# Jasper 7W (W: wide | LH: left-hand chaise)

Jasper can easily be reconfigured to suit your lifestyle and space.

**Jasper 7W** (STD Arms) / or

**Jasper 7W SMART\*** (2x A104 SMART Arms replace 2x A104 STD Arms)

\*SMART Arms compatible with SMART Accessories: Brackets | Lights | Tables | Wireless Device Charging.

Components: 1x P208, 1x P208D, 1x P234, 1x C182D, 1x C182, 2x C104, 4x A104, 1x A208, 3x B104, 1x B78.

\*Shelves: STD (included); or Light-Charge (sold separately): 2x T104, 1x T78.

Configurations (SMART Arms shown):

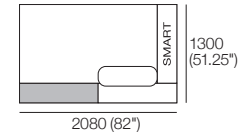
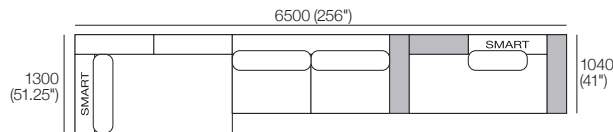
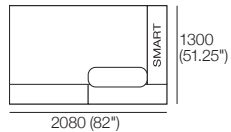
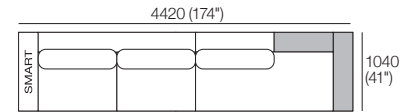
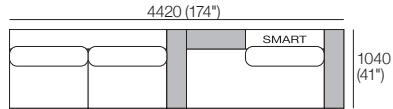
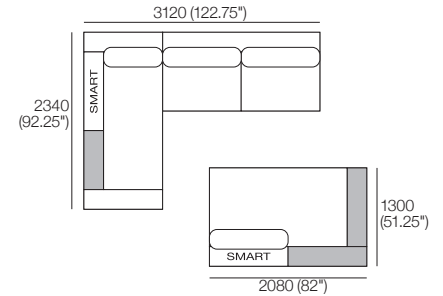
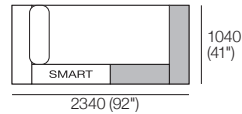
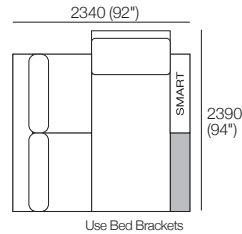
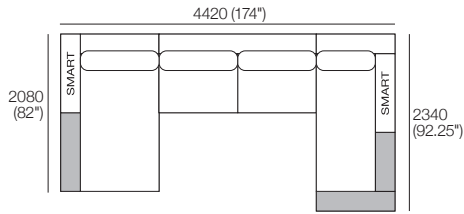



# Jasper 7W SLH 208D (W: wide | S: storage | LH: left-hand chaise)

Jasper can easily be reconfigured to suit your lifestyle and space.

**Jasper 7W SLH 208D** (STD Arms) / or

**Jasper 7W SLH 208D SMART\*** (2x A104 SMART Arms replace 2x A104 STD Arms)

\*SMART Arms compatible with SMART Accessories: Brackets | Lights | Tables | Wireless Device Charging.

Components: 1x S Base 208D S104 LH, 1x P208, 1x P234, 1x C182, 2x C104, 4x A104, 1x A208, 3x B104, 1x B78.

\*Shelves: STD (included); or Light-Charge (sold separately): 2x T104, 1x T78.

Configurations (SMART Arms shown):

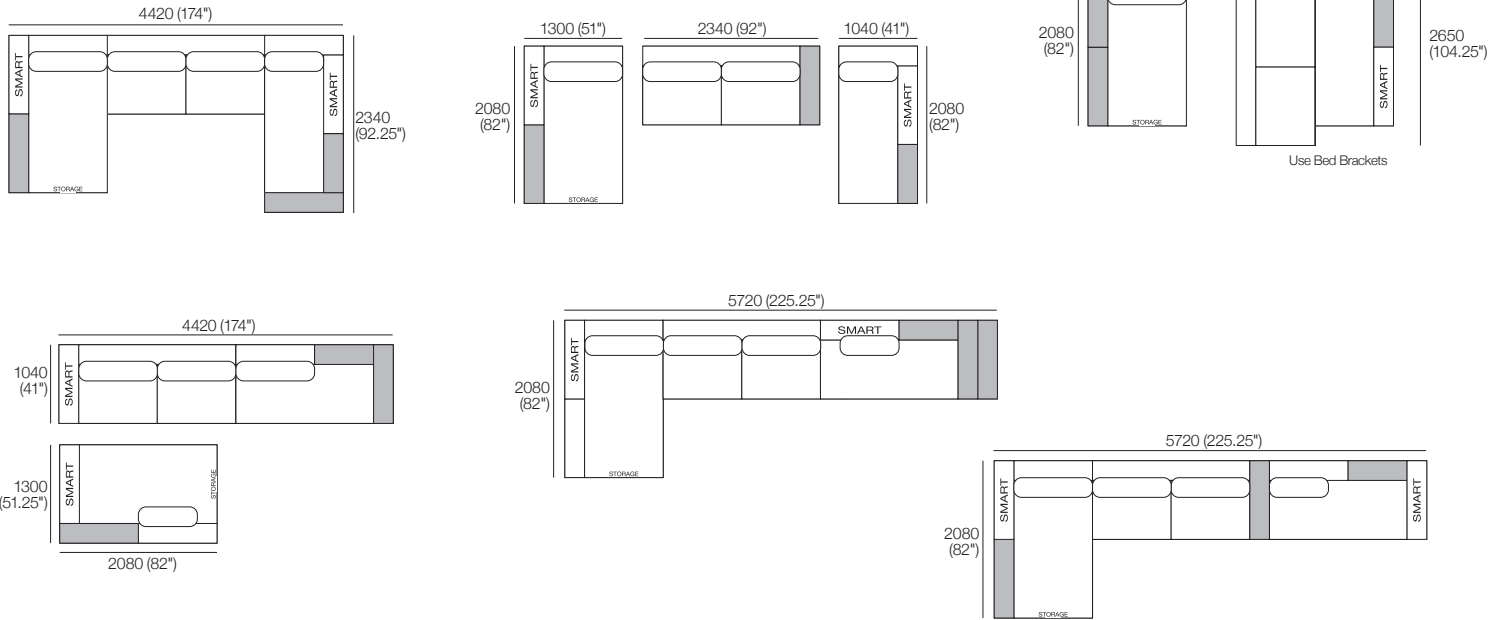

# Jasper 7W SRH 208D (W: wide | S: storage | RH: right-hand chaise)

Jasper can easily be reconfigured to suit your lifestyle and space.

**Jasper 7W SRH 208D** (STD Arms) / or

**Jasper 7W SRH 208D SMART\*** (2x A104 SMART Arms replace 2x A104 STD Arms)

\*SMART Arms compatible with SMART Accessories: Brackets | Lights | Tables | Wireless Device Charging.

Components: 1x S Base 208D S104 RH, 1x P208, 1x P234, 1x C182, 2x C104, 4x A104, 1x A208, 3x B104, 1x B78.

\*Shelves: STD (included); or Light-Charge (sold separately): 2x T104, 1x T78.

Configurations (SMART Arms shown):

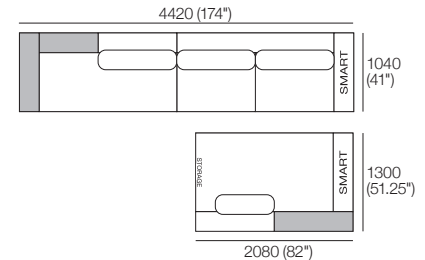
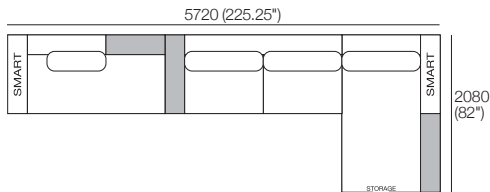
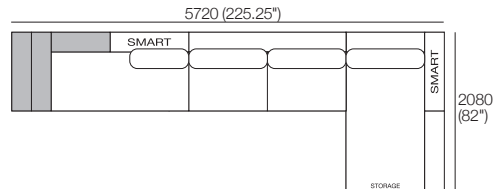
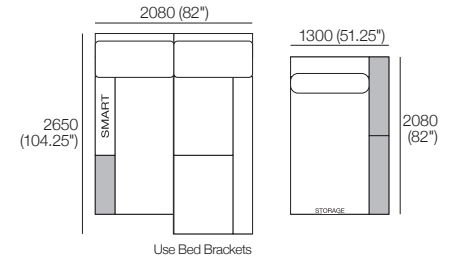
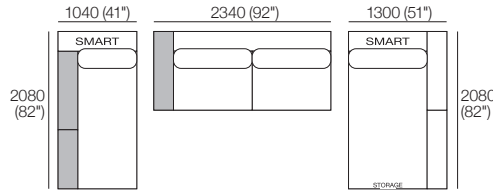
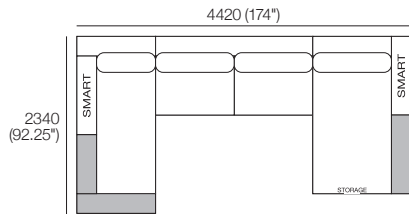

**K I N G**



DT2018646-V3

[kingliving.com](http://kingliving.com)

Jasper 9

# Jasper 9

Jasper can easily be reconfigured to suit your lifestyle and space.

## Jasper 9 (STD Arms)

Components: 1x P234, 1x P208, 2x C104, 1x C182, 2x A104, 1x A208, 2x B104, 1x B78.

\*Shelves: STD (included); or Light-Charge (sold separately): 1x T104, 1x T78.

Configurations:

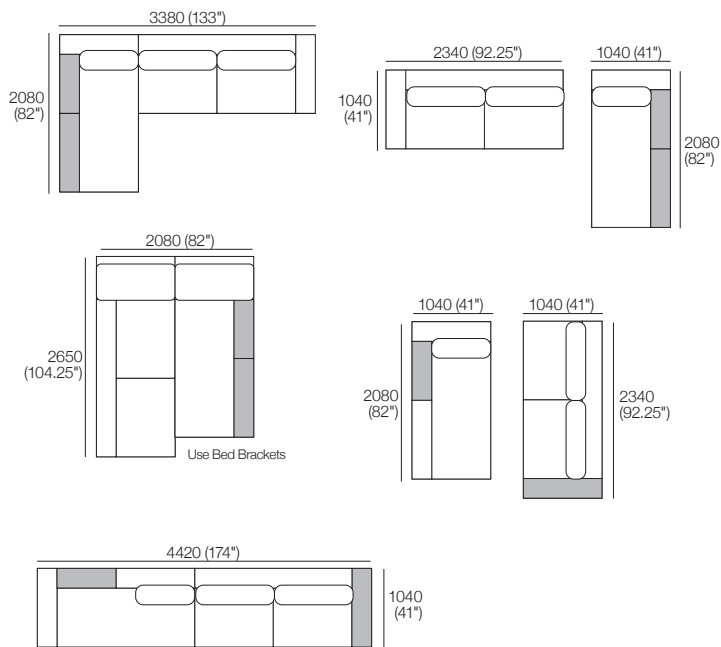

## Jasper 9 SMART\* (1x A104 SMART Arm replaces 1x A104 STD Arm)

\*SMART Arms compatible with SMART Accessories: Brackets | Lights | Tables | Wireless Device Charging.

Components: 1x P234, 1x P208, 2x C104, 1x C182, 1x A104, 1x A104 SMART, 1x A208, 2x B104, 1x B78.

\*Shelves: STD (included); or Light-Charge (sold separately): 1x T104, 1x T78.

Configurations:

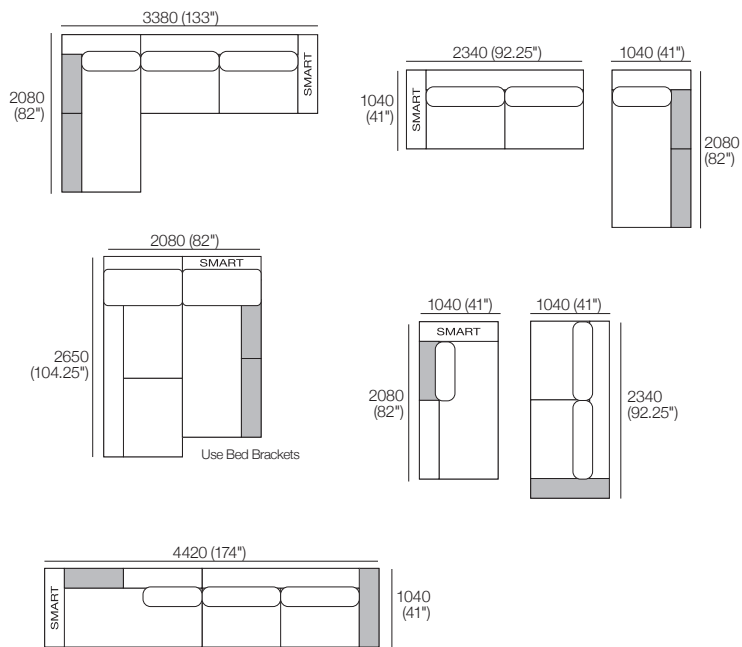

# Jasper 9 SLH S234 (S: storage | LH: left-hand chaise)

Jasper can easily be reconfigured to suit your lifestyle and space.

## Jasper 9 SLH S234 (STD Arms)

Components: 1x SBase 234 S208 RH, 1x P208, 1x C182, 1x A208, 2x A104, 2x B104, 1x B78.

\*Shelves: STD (included); or Light-Charge (sold separately): 1x T104, 1x T78.

Configurations:

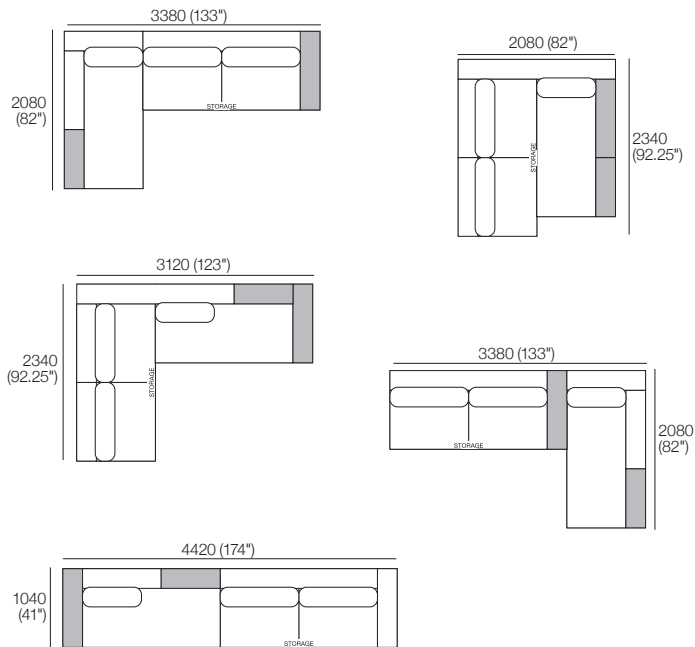

## Jasper 9 SLH S234 SMART\* (1x A104 SMART replaces 1x A104 STD Arm)

\*SMART Arms compatible with SMART Accessories: Brackets | Lights | Tables | Wireless Device Charging.

Components: 1x SBase 234 S208 RH, 1x P208, 1x C182, 1x A208, 1x A104 SMART, 2x B104, 1x B78.

\*Shelves: STD (included); or Light-Charge (sold separately): 1x T104, 1x T78.

Configurations:

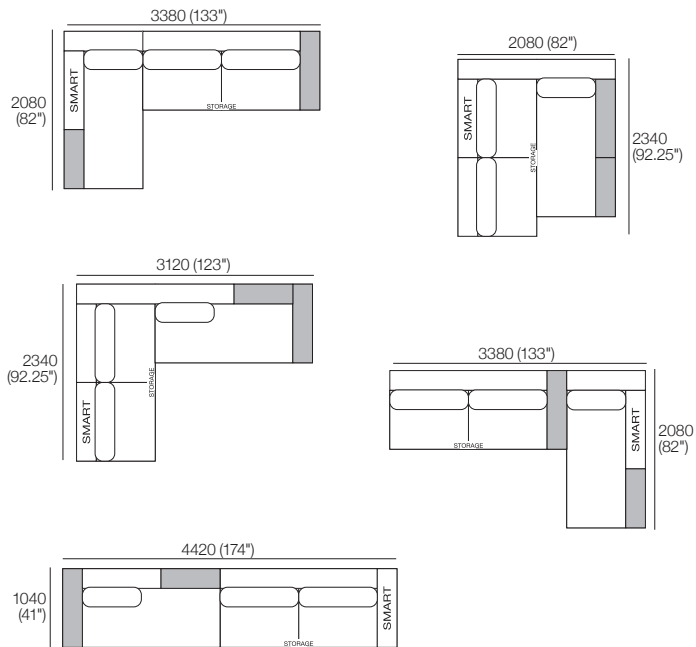

# Jasper 9 SRH S234 (S: storage | RH: right-hand chaise)

Jasper can easily be reconfigured to suit your lifestyle and space.

## Jasper 9 SRH S234 (STD Arms)

Components: 1x SBase 234 C208 LH, 1x P208, 1x C182, 1x A208, 2x A104, 2x B104, 1x B78.

\*Shelves: STD (included); or Light-Charge (sold separately): 1x T104, 1x T78.

Configurations:

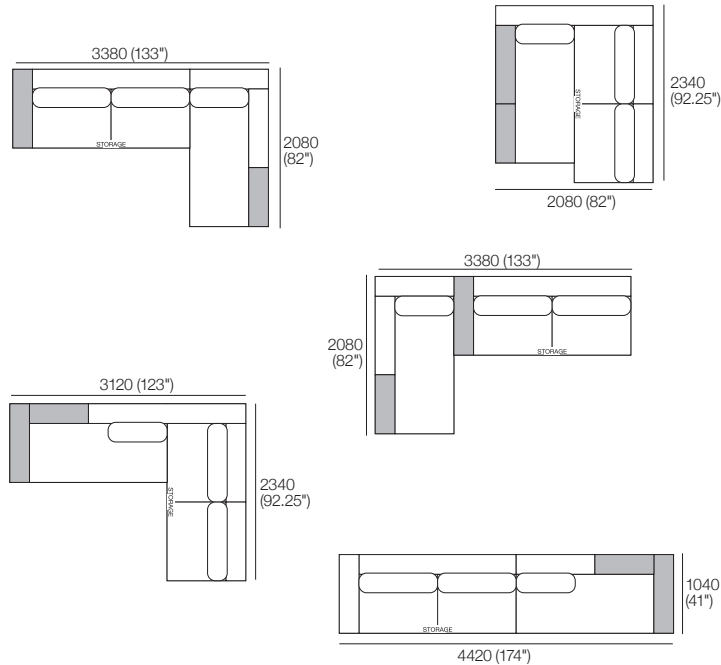

## Jasper 9 SRH S234 SMART\* (1x A104 SMART Arm replaces 1x A104 STD Arm)

\*SMART Arms compatible with SMART Accessories: Brackets | Lights | Tables | Wireless Device Charging.

Components: 1x SBase 234 C208 LH, 1x P208, 1x C182, 1x A208, 1x A104, 1x A104 SMART, 2x B104, 1x B78.

\*Shelves: STD (included); or Light-Charge (sold separately): 1x T104, 1x T78.

Configurations:

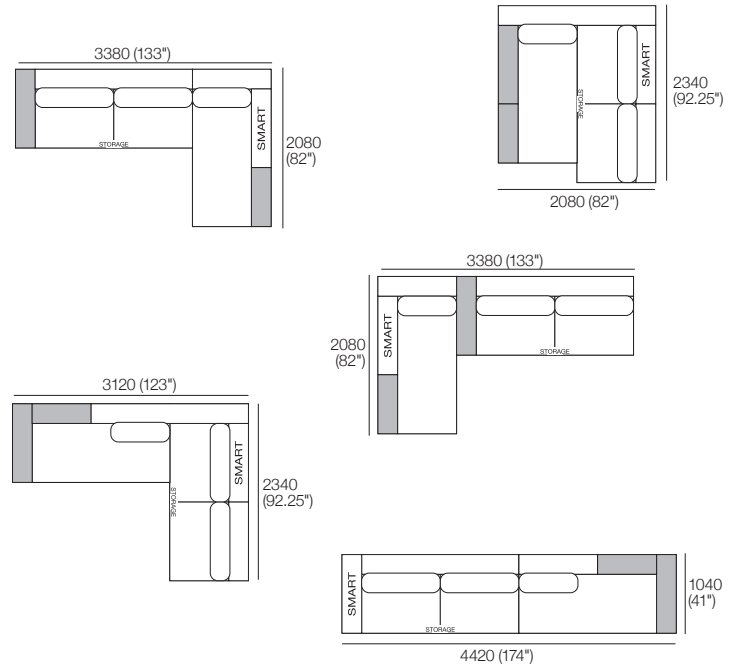

**K I N G**



DT2018643-V6

[kingliving.com](http://kingliving.com)

Jasper 13

# Jasper 13

Jasper can easily be reconfigured to suit your lifestyle and space.

## Jasper 13 (STD Arms)

Components: 2x P182, 2x C156, 1x A104, 1x A156, 1x A78, 3x B78.

\*Shelves: STD (included); or Light-Charge (sold separately): 1x T104, 1x T78.

Configurations:

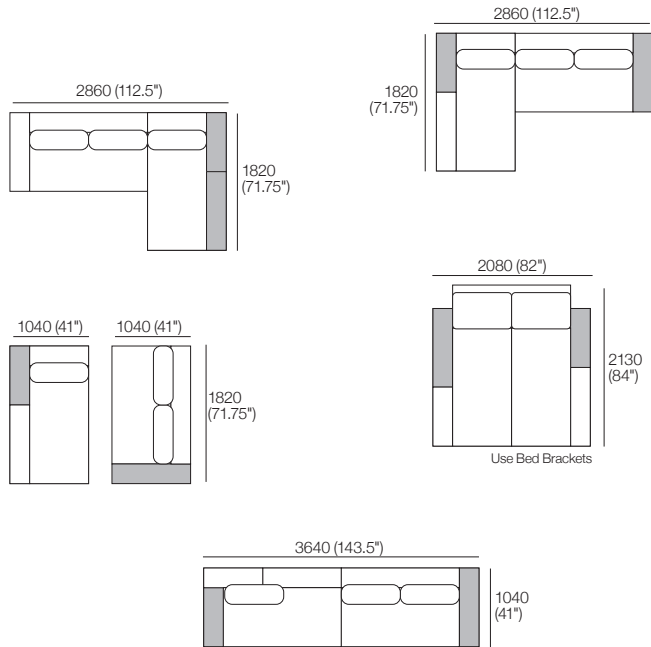

## Jasper 13 SMART\* (1x A104 SMART Arm replaces 1x A104 STD Arm)

\*SMART Arms compatible with SMART Accessories: Brackets | Lights | Tables | Wireless Device Charging.

Components: 2x P182, 2x C156, 1x A104 SMART, 1x A156, 1x A78, 3x B78.

\*Shelves: STD (included); or Light-Charge (sold separately): 1x T104, 1x T78.

Configurations:

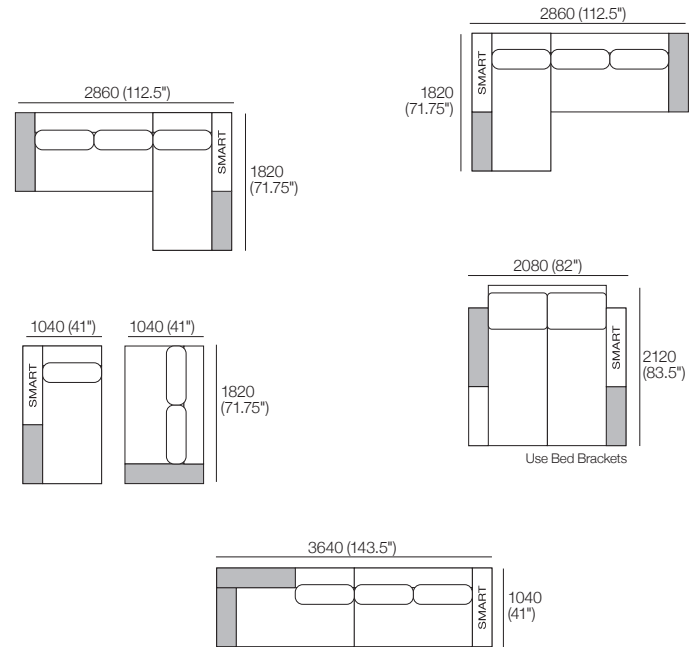



# Jasper 13 SLH (S: storage | LH: left-hand chaise)

Jasper can easily be reconfigured to suit your lifestyle and space.

## Jasper 13 SLH (STD Arms)

Components: 1x SBase 182 S156 RH, 1x SBase 182 S78 LH, 1x A104, 1x A156, 1x A78, 3x B78.

\*Shelves: STD (included); or Light-Charge (sold separately): 1x T104, 1x T78.

Configurations:

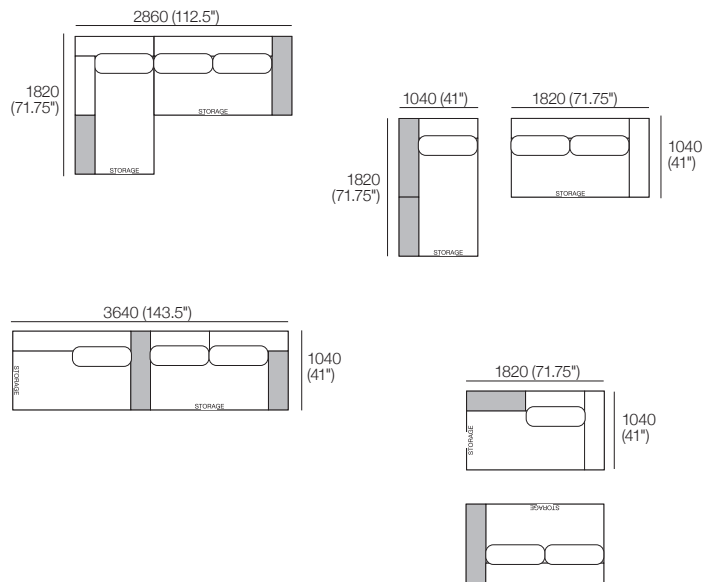

## Jasper 13 SLH SMART\* (1x A104 SMART Arm replaces 1x A104 STD Arm)

\*SMART Arms compatible with SMART Accessories: Brackets | Lights | Tables | Wireless Device Charging.

Components: 1x SBase 182 S156 RH, 1x SBase 182 S78 LH, 1x A104 SMART, 1x A156, 1x A78, 3x B78.

\*Shelves: STD (included); or Light-Charge (sold separately): 1x T104, 1x T78.

Configurations:

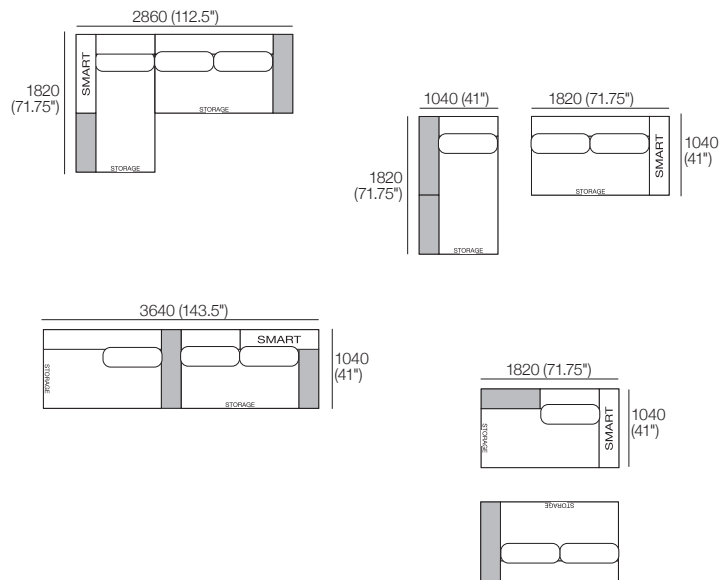

# Jasper 13 SRH (S: storage | RH: right-hand chaise)

Jasper can easily be reconfigured to suit your lifestyle and space.

## Jasper 13 SRH (STD Arms)

Components: 1x SBase 182 S156 LH, 1x SBase 182 S78 RH, 1x A104, 1x A156, 1x A78, 3x B78.

\*Shelves: STD (included); or Light-Charge (sold separately): 1x T104, 1x T78.

Configurations:

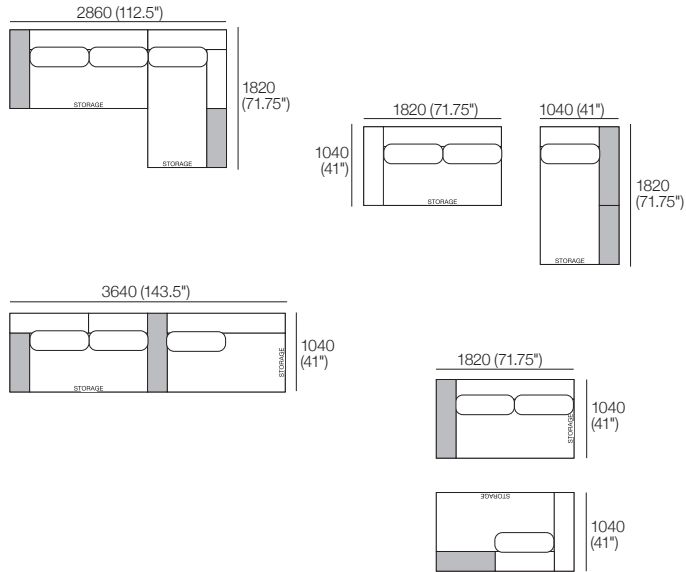

## Jasper 13 SRH SMART\* (1x A104 SMART Arm replaces 1x A104 STD Arm)

\*SMART Arms compatible with SMART Accessories: Brackets | Lights | Tables | Wireless Device Charging.

Components: 1x SBase 182 S156 LH, 1x SBase 182 S78 RH, 1x A104 SMART, 1x A156, 1x A78, 3x B78.

\*Shelves: STD (included); or Light-Charge (sold separately): 1x T104, 1x T78.

Configurations:

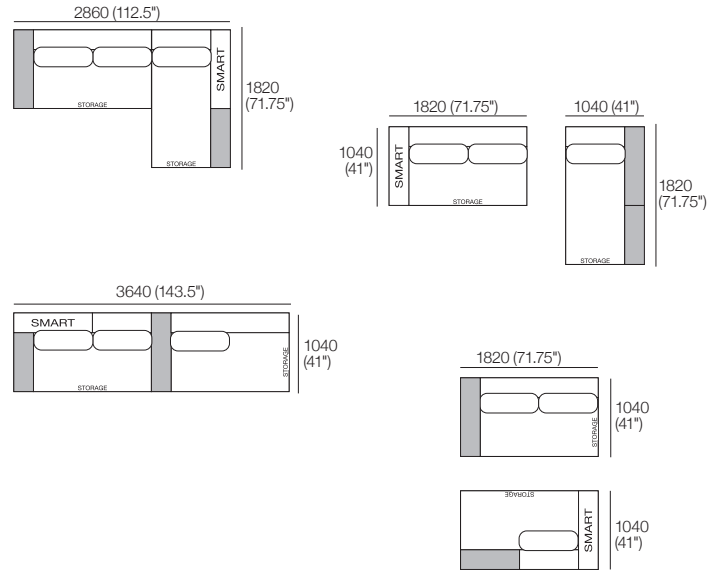

**K I N G**



DT2018644-V3

kingliving.com

Jasper 13U

# Jasper 13U

Jasper can easily be reconfigured to suit your lifestyle and space.

## Jasper 13U (STD Arms)

Components: 2x P182, 2x C156, 2x A104, 1x A156, 2x A78, 3x B78.

Configurations:

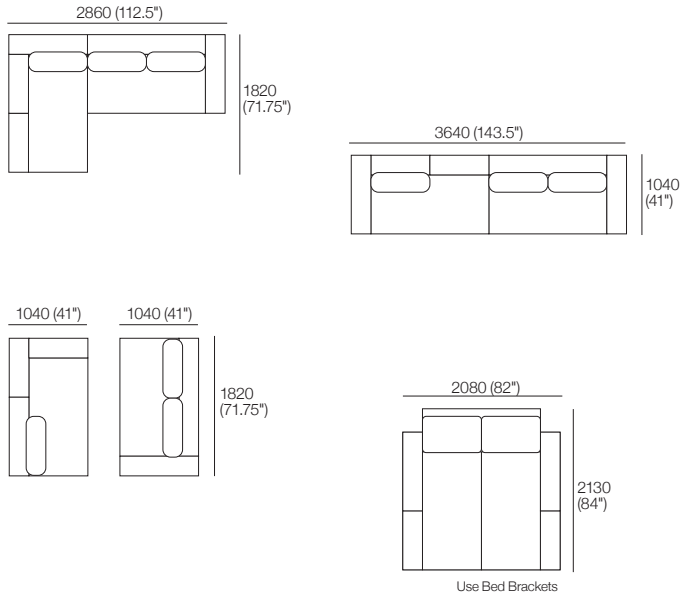

## Jasper 13U SMART\* (2x A104 SMART Arms replaces 2x A104 STD Arms)

\*SMART Arms compatible with SMART Accessories: Brackets | Lights | Tables | Wireless Device Charging.

Components: 2x P182, 2x C156, 2x A104 SMART, 1x A156, 2x A78, 3x B78.

Configurations:

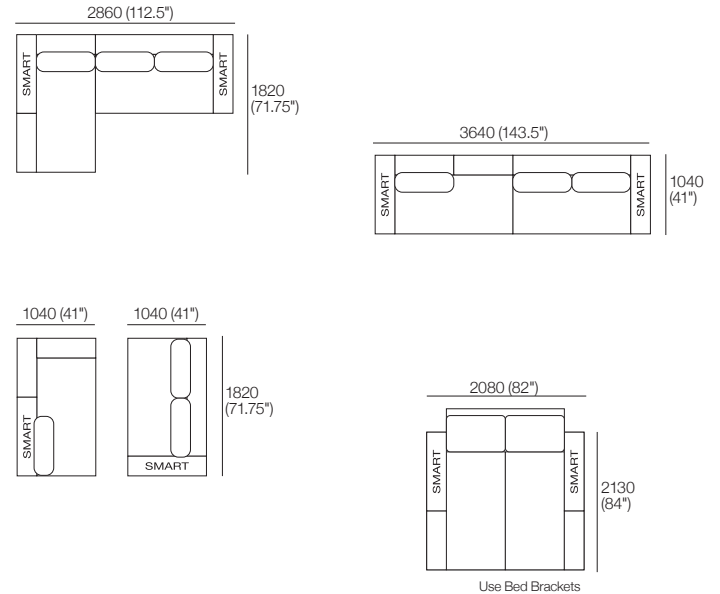

# Jasper 13U SLH (S: storage | LH: left-hand chaise)

Jasper can easily be reconfigured to suit your lifestyle and space.

## Jasper 13U SLH (STD Arms)

Components: 1x SBase 182 S156 RH, 1x SBase 182 S78 LH,  
1x A156, 2x A104, 2x A78, 3x B78.

Configurations:

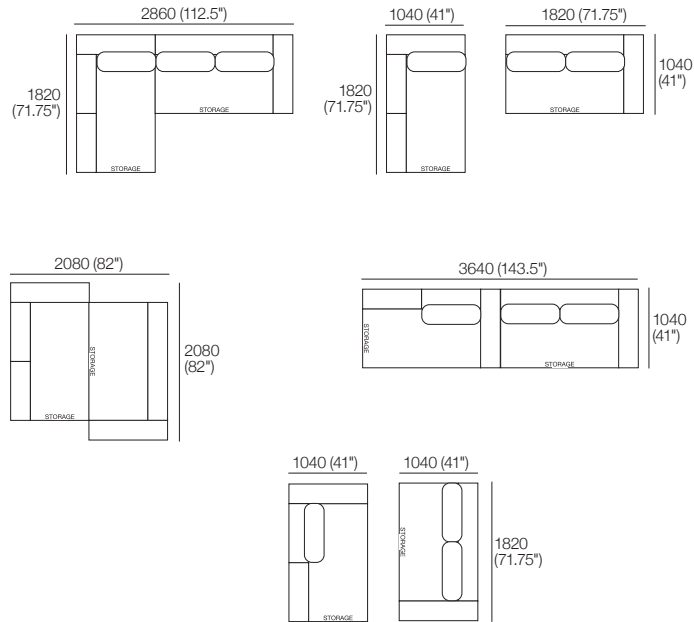

## Jasper 13U SLH SMART\* (2x A104 SMART Arms replaces 2x A104 STD Arms)

\*SMART Arms compatible with SMART Accessories: Brackets | Lights | Tables | Wireless Device Charging.

Components: 1x SBase 182 S156 RH, 1x SBase 182 S78 LH,  
1x A156, 2x A104 SMART, 2x A78, 3x B78.

Configurations:

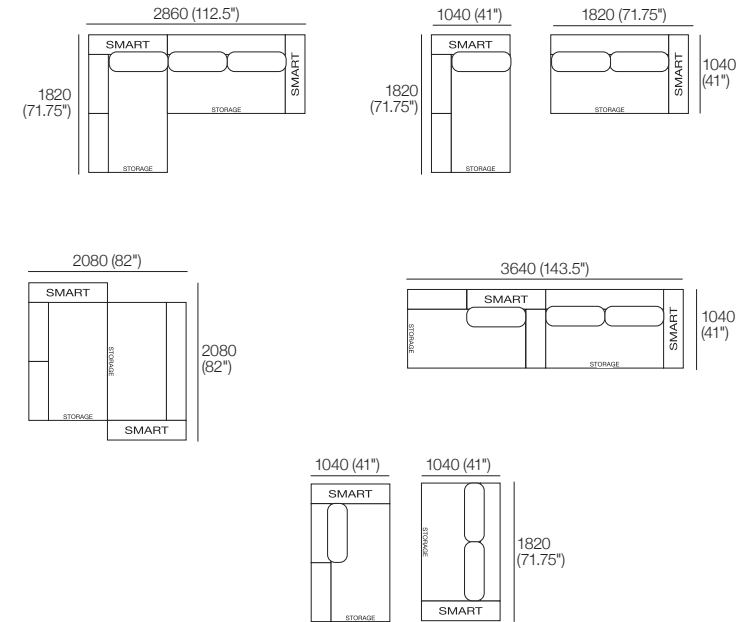

# Jasper 13U SRH (S: storage | RH: right-hand chaise)

Jasper can easily be reconfigured to suit your lifestyle and space.

## Jasper 13U SRH (STD Arms)

Components: 1x SBase 182 S156 LH, 1x SBase 182 S78 RH,  
1x A156, 2x A104, 2x A78, 3x B78.

Configurations:

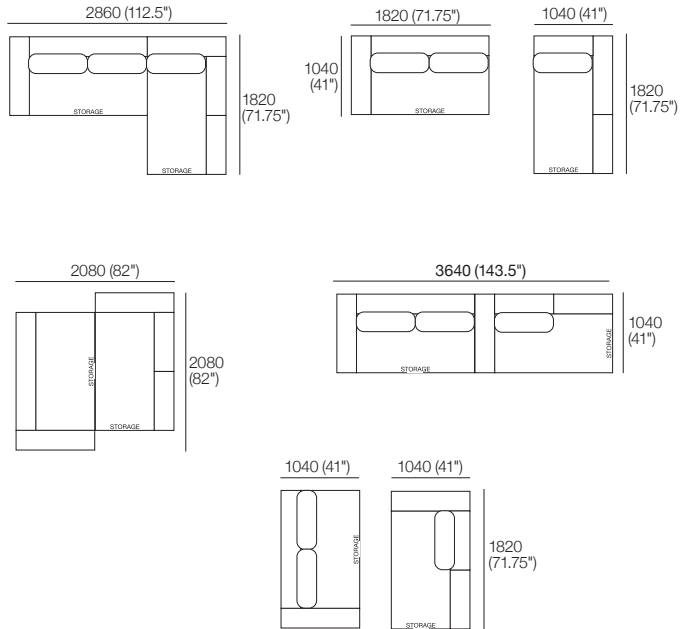

## Jasper 13U SRH SMART\* (2x A104 SMART Arms replaces 2x A104 STD Arms)

\*SMART Arms compatible with SMART Accessories: Brackets | Lights | Tables | Wireless Device Charging.

Components: 1x SBase 182 S156 LH, 1x SBase 182 S78 RH,  
1x A156, 2x A104 SMART, 2x A78, 3x B78.

Configurations:

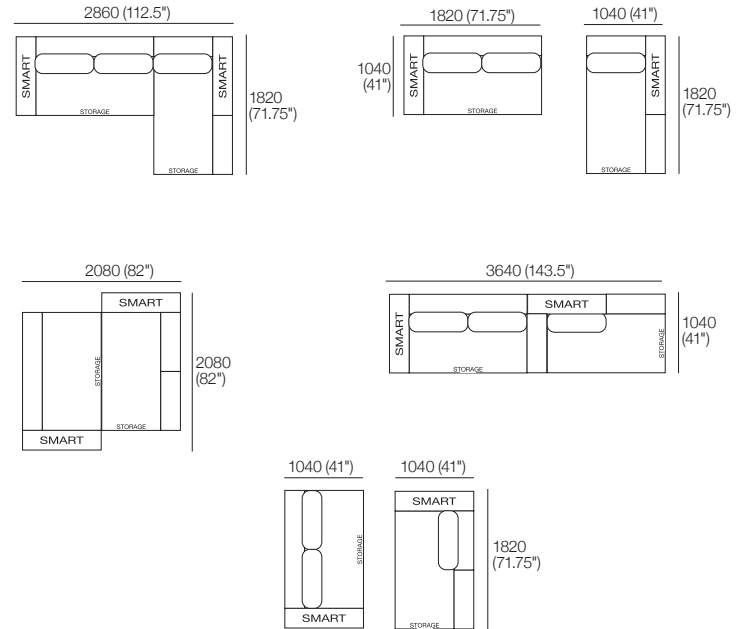

K I N G



DT20230305-V6

kingliving.com

Jasper Curved Corner

# Jasper C1 1T | Jasper C1 2T (C: Curve Corner\* | T: Shelves\*)

Jasper can easily be reconfigured to suit your lifestyle and space.

**Jasper C1 1T** (STD Arms) / or

**Jasper C1 1T SMART\*** (2x A104 SMART Arms replace 2x A104 STD Arms)

\*SMART Arms for SMART Accessories: Brackets | Lights | Tables | Wireless Device Charging.

Components: 1x Platform P208, 1x Platform P208D, 1x Platform P104,  
1x Platform P-CNR R130, 3x Seat Cushion C104, 1x Seat Cushion C182D,  
1x Seat Cushion C-CNR R104, 3x Arm A104, 1x Arm A208, 1x Arm **CNR R130**,  
4x Back Cushion B104, 2x Back Cushion B78.

\*Shelves: STD (included); or Light-Charge (sold separately): 1x T104.

Configurations (SMART Arm shown):

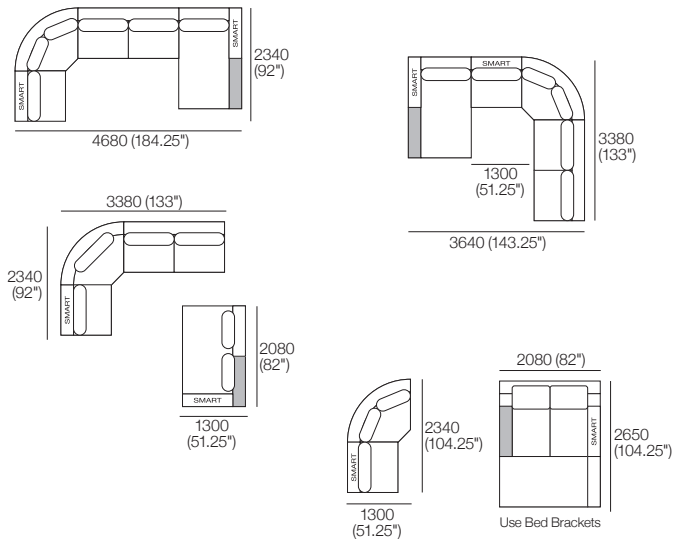

**Jasper C1 2T** (STD Arms) / or

**Jasper C1 2T SMART\*** (2x A104 SMART Arms replace 2x A104 STD Arms)

\*SMART Arms for SMART Accessories: Brackets | Lights | Tables | Wireless Device Charging.

Components: 1x Platform P208, 1x Platform P208D, 1x Platform P104,  
1x Platform P-CNR R130, 3x Seat Cushion C104, 1x Seat Cushion C182D,  
1x Seat Cushion C-CNR R104, 3x Arm A104, 1x Arm A208,  
4x Back Cushion B104, 2x Back Cushion B78.

\*Shelves: STD (included); or Light-Charge (sold separately): 1x T104, 1x **T-CNR R130** (STD only)

Configurations (SMART Arms shown):

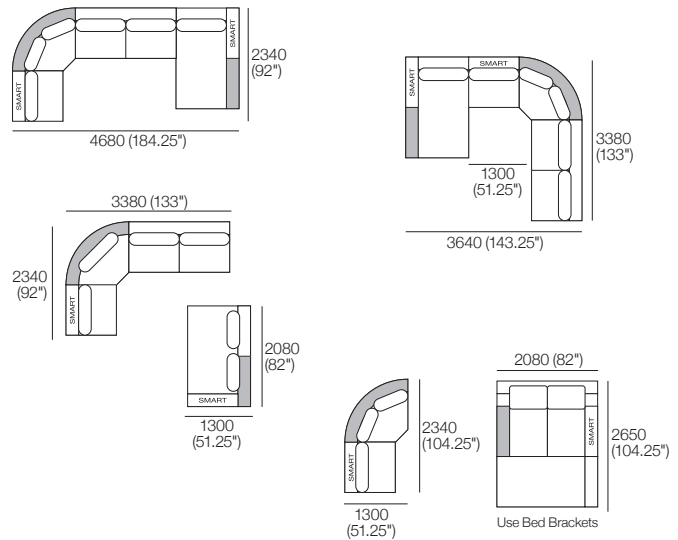



# Jasper C2 1T | Jasper C2 2T (C: Curve Corner\* | T: Shelves\*)

Jasper can easily be reconfigured to suit your lifestyle and space.

## Jasper C2 1T (STD Arms) / or

### Jasper C2 1T SMART\* (2x A104 SMART Arms replace 2x A104 STD Arms)

\*SMART Arms for SMART Accessories: Brackets | Lights | Tables | Wireless Device Charging.

Components: 1x Platform P156, 1x Platform P182, 1x Platform P104, 1x Platform P-CNR R130, 2x Seat Cushion C156, 1x Seat Cushion C104, 1x Seat Cushion C-CNR R104, 2x Arm A104, 1x Arm A78, 1x Arm A156, 1x Arm CNR R130, 1x Back Cushion B104, 5x Back Cushion B78.

\*Shelves: STD (included); or Light-Charge (sold separately): 1x T78.

Configurations (SMART Arms shown):

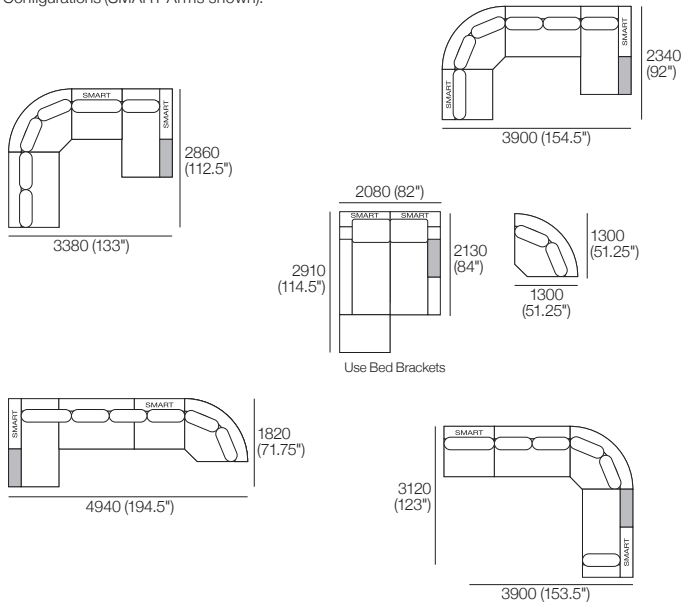

## Jasper C2 2T (STD Arms) / or

### Jasper C2 2T SMART\* (2x A104 SMART Arms replace 2x STD A104 Arms)

\*SMART Arms for SMART Accessories: Brackets | Lights | Tables | Wireless Device Charging.

Components: 1x Platform P156, 1x Platform P182, 1x Platform P104, 1x Platform P-CNR R130, 2x Seat Cushion C156, 1x Seat Cushion C104, 1x Seat Cushion C-CNR R104, 2x Arm A104, 1x Arm A78, 1x Arm A156, 1x Back Cushion B104, 5x Back Cushion B78.

\*Shelves: STD (included); or Light-Charge (sold separately): 1x T78, 1x T-CNR R130 (STD only).

Configurations (SMART Arms shown):

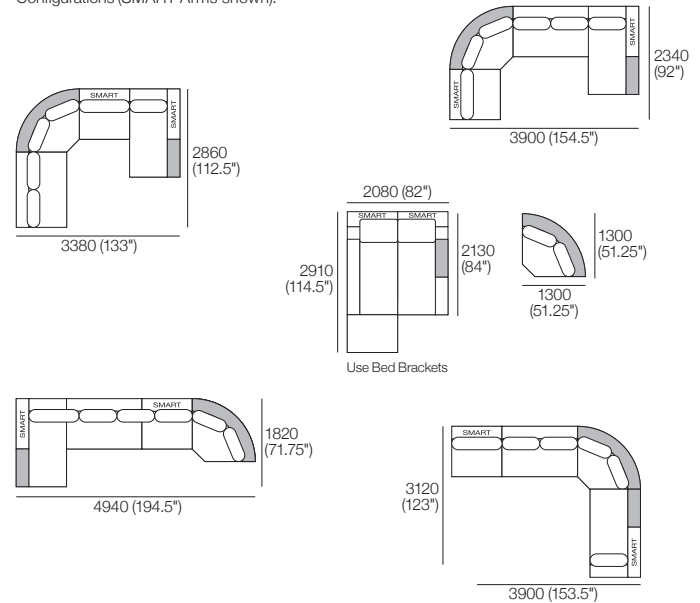



**K I N G**



DT2018666-V4

[kingliving.com](http://kingliving.com)

Jasper Corners & Ends

# Jasper Corners & Ends

Jasper can easily be reconfigured to suit your lifestyle and space.

## Package: Corner 130 (STD Arms)

Components: 1x P130 Corner, 1x C104 78 Corner, 1x A104, 1x A130, 1x B91, 1x B104.

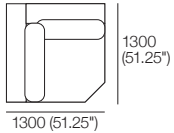

## Package: 2 STR END SLH (STD Arm)

Components: 1x SBBase 182 S156 LH, 1x A156, 2x B78.  
\*Shelves: STD (included); or Light-Charge (sold separately): 1x T104.

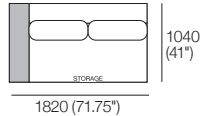

## Package: 2.5 STR END (STD Arms)

Components: 1x P208, 1x C182, 2x A104, 2x B91.  
\*Shelves: STD (included); or Light-Charge (sold separately): 1x T78.

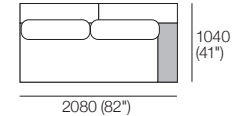

## Package: 2 STR END (STD Arm)

Components: 1x P182, 1x C156, 1x A156, 2x B78.  
\*Shelves: STD (included); or Light-Charge (sold separately): 1x T104.

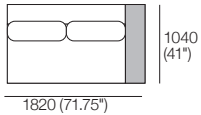

## Package: 2 STR END SRH (STD Arm)

Components: 1x SBBase 182 S156 RH, 1x A156, 2x B78.  
\*Shelves: STD (included); or Light-Charge (sold separately): 1x T104.

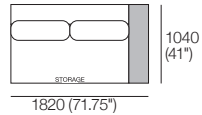

K I N G



DT2018612-V6

[kingliving.com](http://kingliving.com)

Jasper Chairs

# Jasper Chairs

Jasper can easily be reconfigured to suit your lifestyle and space.

## Jasper Chair 104T (STD Arm)

Components: 1x P104, 1x C78, 1x A78, 1x B78.

\*Shelves: STD (included); or Light-Charge (sold separately): 1x T104.

Configurations:

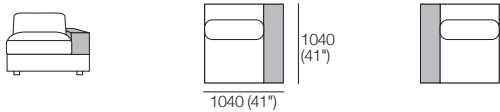

## Jasper Chair 130T (STD Arm)

Components: 1x P130, 1x C104, 1x A104, 1x B104.

\*Shelves: STD (included); or Light-Charge (sold separately): 1x T104.

Configurations:

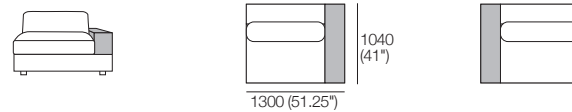

## Jasper Chair 104T SMART\*

\*SMART Arms compatible with SMART Accessories: Brackets | Lights | Tables | Wireless Device Charging.

Components: 1x P104, 1x C78, 1x A78 SMART, 1x B78.

\*Shelves: STD (included); or Light-Charge (sold separately): 1x T104.

Configurations:

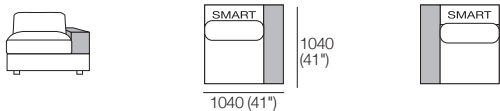

## Jasper Chair 130T SMART\*

\*SMART Arms compatible with SMART Accessories: Brackets | Lights | Tables | Wireless Device Charging.

Components: 1x P130, 1x C104, 1x A104 SMART, 1x B104.

\*Shelves: STD (included); or Light-Charge (sold separately): 1x T104.

Configurations:

